

|          |  |
|----------|--|
| PROJECT  |  |
| TYPE     |  |
| NOTES    |  |
| QUANTITY |  |
| DATE     |  |

## WILLY 60 SUSPENSION

### D81014-BLK

#### GENERAL

Series: Willy  
 Subseries: Willy 60  
 Brand: Panzeri  
 Division: Design  
 Mounting Type: Suspension  
 Mounting Location: Ceiling  
 Subcategory: Pendant

#### PHYSICAL

Shape: Dome  
 Diameter (mm): 600  
 Diameter (in): 23 5/8  
 Height (mm): 370  
 Height (in): 14 7/16  
 Max. Overall Height (mm): 2370  
 Max. Overall Height (in): 93 5/16  
 Light Distribution: Direct / Indirect  
 Weight (kg): 10.22  
 Weight (lbs): 22.53  
 Diffuser: Black Blown Glass Dome and Frosted White Glass Bottom Diffuser  
 Fixture Material: Glass / Aluminum  
 Cable Details: 2000mm (78 3/4") Long Steel Suspension Cables / 2200mm (86 5/8") Long Power Cable In Transparent PVC

#### ELECTRICAL

Number of Lamps: 3  
 Lamp Type: LED Retrofit  
 Bulb Included: Bulb Not Included  
 Total Output Wattage (W): 45  
 Max. Wattage Per Lamp (W): 15  
 Lamp Base: E26  
 Input Voltage (V): 120

#### LED

#### OPTICAL

#### RATINGS AND CERTIFICATIONS

Certified By: CSA Certified to UL and CSA Standards  
 IP rating: IP20

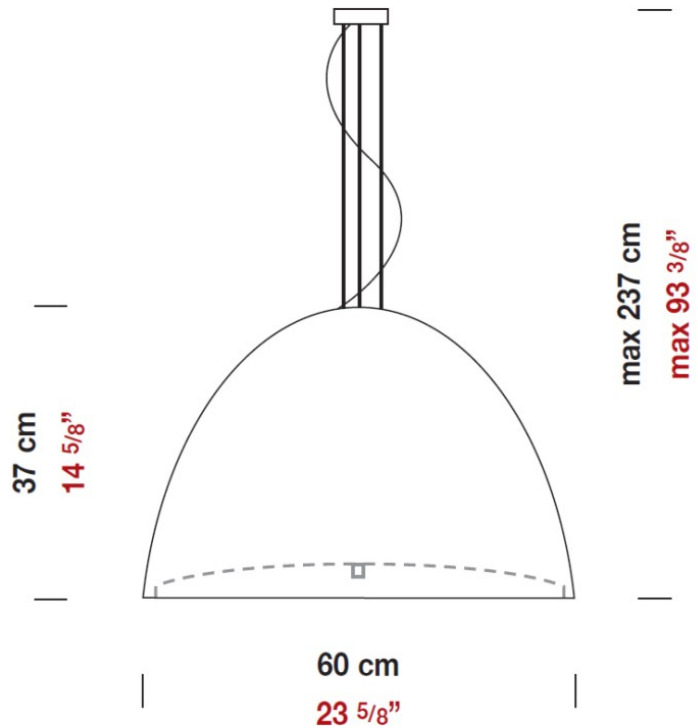

## WILLY 40 SUSPENSION

### D81057-BLK

#### GENERAL

Series: Willy

Subseries: Willy 40

Brand: Panzeri

Division: Design

Mounting Type: Suspension

Mounting Location: Ceiling

Subcategory: Pendant

#### PHYSICAL

Shape: Dome

Diameter (mm): 400

Diameter (in): 15 3/4

Height (mm): 280

Height (in): 11

Max. Overall Height (mm): 2280

Max. Overall Height (in): 89 3/4

Light Distribution: Direct

Weight (kg): 4.09

Weight (lbs): 9.02

Diffuser: Black Blown Glass Dome and Frosted White Glass Bottom

Fixture Finish: BLK

Holder Finish: Metallized Gray

Fixture Material: Blown Glass Lampshade

Cable Details: 2000mm (78 3/4") Long Steel Suspension Cables / 2200mm (86 5/8") Long Power Cable In Transparent PVC

#### ELECTRICAL

Number of Lamps: 1

Lamp Type: LED Retrofit

Lamp Shape: A19

Bulb Included: Bulb Not Included

Total Output Wattage (W): 15

Max. Wattage Per Lamp (W): 15

Lamp Base: E26

Driver Included: No

Input Voltage (V): 120

#### LED

#### OPTICAL

#### RATINGS AND CERTIFICATIONS

Certified By: CSA Certified to UL and CSA Standards

IP rating: IP20

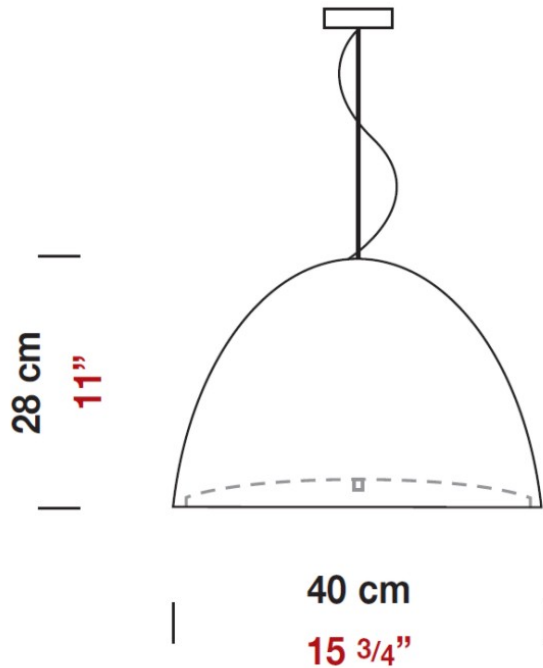

## WILLY 40 SUSPENSION

### D81057-WHI

#### GENERAL

Series: Willy

Subseries: Willy 40

Brand: Panzeri

Division: Design

Mounting Type: Suspension

Mounting Location: Ceiling

Subcategory: Pendant

#### PHYSICAL

Shape: Dome

Diameter (mm): 400

Diameter (in): 15 3/4

Height (mm): 280

Height (in): 11

Max. Overall Height (mm): 2280

Max. Overall Height (in): 89 3/4

Weight (kg): 4.09

Weight (lbs): 9.02

Diffuser: White Blown Glass Dome and Frosted White Bottom

Fixture Finish: WHI

Holder Finish: Metallized Gray

Fixture Material: Blown Glass Lampshade

#### ELECTRICAL

Number of Lamps: 1

Lamp Type: LED Retrofit

Bulb Included: Bulb Not Included

Total Output Wattage (W): 15

Max. Wattage Per Lamp (W): 15

Lamp Base: E26

Driver Included: No

Input Voltage (V): 120

#### LED

#### OPTICAL

#### RATINGS AND CERTIFICATIONS

Certified By: CSA Certified to UL and CSA Standards

IP rating: IP20

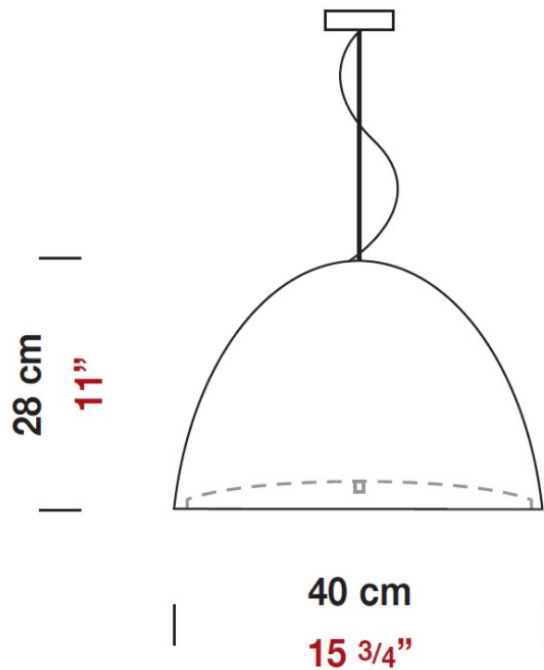

## WILLY SUSPENSION

### D81060

#### GENERAL

Series: Willy

Brand: Panzeri

Division: Design

Mounting Type: Suspension

Mounting Location: Ceiling

Subcategory: Pendant

#### PHYSICAL

Shape: Bell

Diameter (mm): 160

Diameter (in): 6 ¼

Height (mm): 250

Height (in): 9 ⅞

Max. Overall Height (mm): 2250

Max. Overall Height (in): 88 ⅞

Light Distribution: Direct

Weight (kg): 1.23

Weight (lbs): 2.7

Diffuser: Black Blown Glass

Fixture Finish: Metallic Gray

Fixture Material: Metal

#### ELECTRICAL

Number of Lamps: 1

Lamp Type: LED Retrofit

Lamp Shape: T4

Bulb Included: Bulb Not Included

Total Output Wattage (W): 3

Max. Wattage Per Lamp (W): 3

Lamp Base: G9

Input Voltage (V): 120

#### LED

#### OPTICAL

#### RATINGS AND CERTIFICATIONS

Certified By: CSA Certified to UL and CSA Standards

IP rating: IP20

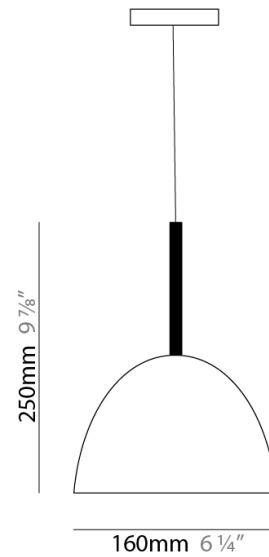

## WILLY SUSPENSION

### D81344

#### GENERAL

Series: Willy

Brand: Panzeri

Division: Design

Mounting Type: Suspension

Mounting Location: Ceiling

Subcategory: Pendant

#### PHYSICAL

Shape: Bell

Diameter (mm): 600

Diameter (in): 23 5/8"

Height (mm): 370

Height (in): 14 9/16"

Max. Overall Height (mm): 2370

Max. Overall Height (in): 93 5/16"

Light Distribution: Direct

Weight (kg): 12.2`

Weight (lbs): 27

Diffuser: Metallic Gray Aluminum Dome and Frosted White Glass Bottom Diffuser

Fixture Finish: ALU

Fixture Material: Aluminum

#### ELECTRICAL

Number of Lamps: 3

Lamp Type: LED Retrofit

Bulb Included: Bulb Not Included

Total Output Wattage (W): 45

Max. Wattage Per Lamp (W): 15

Lamp Base: E26

Input Voltage (V): 120

Upon Request: 277Vac / GU24

#### LED

#### OPTICAL

#### RATINGS AND CERTIFICATIONS

Certified By: CSA Certified to UL and CSA Standards

IP rating: IP20

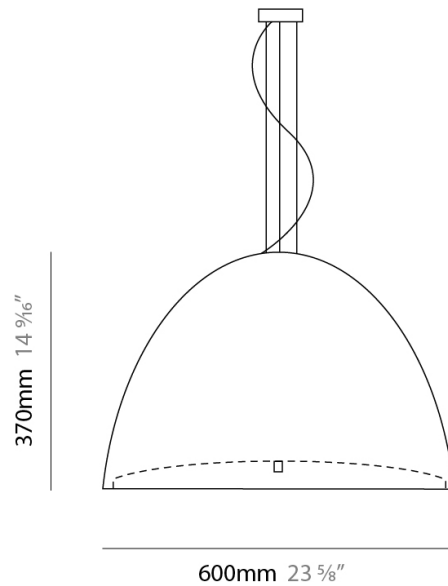

|          |  |
|----------|--|
| PROJECT  |  |
| TYPE     |  |
| NOTES    |  |
| QUANTITY |  |
| DATE     |  |

## WILLY SUSPENSION

### D81564-BLK

#### GENERAL

Series: Willy  
 Brand: Panzeri  
 Division: Design  
 Mounting Type: Suspension  
 Mounting Location: Ceiling

#### PHYSICAL

Diameter (mm): 1000  
 Diameter (in): 39 <sup>3</sup>/<sub>8</sub>  
 Height (mm): 630  
 Height (in): 24 <sup>13</sup>/<sub>16</sub>  
 Max. Overall Height (mm): 2630  
 Max. Overall Height (in): 103 <sup>7</sup>/<sub>16</sub>  
 Light Distribution: Direct  
 Weight (kg): 15.2  
 Weight (lbs): 33.5  
 Diffuser: Black Polyethylene Dome and White Frosted Opal Glass Bottom Diffuser  
 Fixture Material: Polyethylene Lampshade  
 Cable Details: Transparent

#### ELECTRICAL

Input Wattage Range: 30 - 49 W  
 Lamp Type: LED  
 Input Wattage (W): 40  
 Total Output Wattage (W): 40  
 Driver Included: Yes  
 Driver Type: Integral LED Driver in Canopy  
 Constant Current (MA): 1050

#### LED

Color Temperature (°K): 3000  
 Max. Delivered Lumen (lm): 3859  
 CRI: >80 CRI  
 Efficiency (%): 78.12







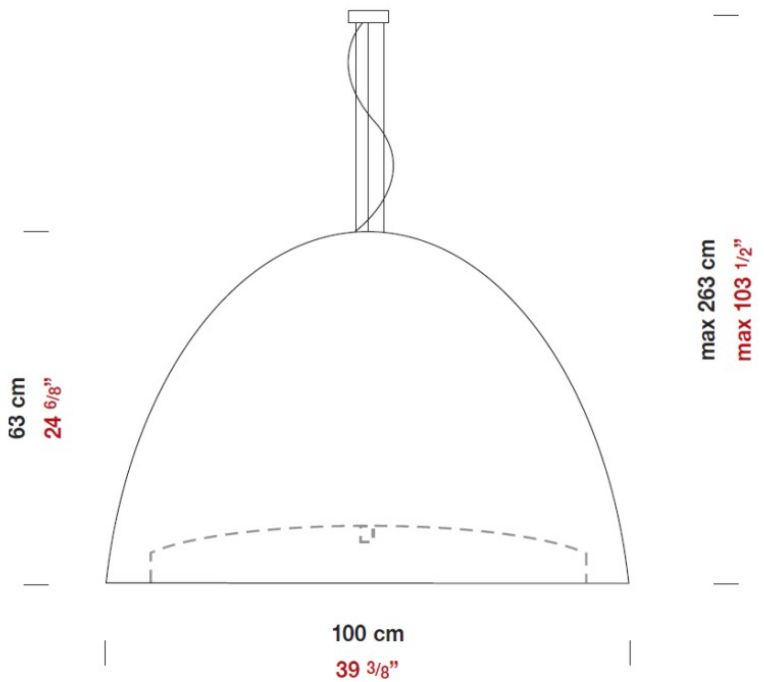





























































#### OPTICAL

#### RATINGS AND CERTIFICATIONS

Certified By: CSA Certified to UL and CSA Standards













## LEGEND

|  |   |   |  |   |  |
|--|---|---|--|---|--|
|    | floor-mounted   |    | pivotable  |    | special LED (upon request) RGB, RGBW, tunable, gold+, meat+, art+, fashion+                    |
|    | wall and ceiling: recessed and surface mounted            |    | rotating   |    | warm dim / natural dimming LED   |
|    | ceiling-mounted and wall-mounted                          |    | illuminate tilted  |    | rechargeable battery powered   |
|    | wall-mounted  |    | color of suspension cable                                    |    | fixture with natural vivid LED (upon request)  |
|    | omni-directional light distribution                       |    | length of suspension cable                                   |    | color rendering index  |
|    | direct light distribution                                 |    | reflector degree selection                                   |    | color temperature  |
|    | direct/indirect light distribution                        |    | super spot   |    | lumen (luminous flux)  |
|    | indirect light distribution                               |    | lens   |    | efficacy (lumens per watt)   |
|    | asymmetric light distribution                             |    | lens pack  |    | Unified Glare Rating (UGR) range from 5-40   |
|    | aura light distribution                                   |    | shine ring   |    | marine grade (AISI 316 stainless steel)  |
|    | round wall or ceiling cut-out                             |    | integrated shine ring with diffuser                          |    | walk on  |
|    | square wall or ceiling cut-out                            |    | free individual colors 01-29                                 |    | drive on   |
|   | the supplied jig specifies the cutout dimensions          |   | individual colors: 00 (free of charge), 01-25 (extra charge) |   | Dark Sky Compliance  |
|  | minimum distance (meters) lamp - object                   |  | luminaire part to be colored (F1)                            |  | Americans with Disabilities Act (less than 4" off the wall located between 27"-84" from floor) |
|  | recessed depth  |  | luminaire part to be colored (F2)                            |  | lamp protected against explosion   |
|  | ceiling thickness in mm                                   |  | luminaire part to be colored (F3)                            |  | blown glass using traditional methods by master glass blower                                   |
|  | ceiling thickness selection                               |  | luminaire part to be colored (F4)                            |  | acoustic material  |
|  | dimmable DP (phase), DV (0-10V), DD (dali), DS (step-dim) |  | luminaire part to be colored (F5)                            |  | protection class I, protection insulation  |
|  | included or excluded LED driver/transformer/control gear  |  | color of 3-circuit adaptor                                   |  | protection class II, protection insulation   |
|  | separately switchable                                     |  | indirect diffuser  |  | ETL Certified to UL and CSA Standards  |
|  | sensor  |  | direct diffuser  |  | UL Certified to UL and CSA Standards   |
|  | remote control  |  | ball-proof (upon request)                                    |  | CSA Certified to UL and CSA Standards  |
|  | available upon request                                    |  | accessory  |  | Certified for North American Standards   |

## IP RATING

|  |  |
|--|--|
|  | protected against ingress of solid bodies greater than 12.5mm (finger)   |
|  | protected against ingress of solid bodies greater than 2.5mm<br>protected against sprays of water up to 60 degrees from the vertical (rain)      |
|  | protected against ingress of solid bodies greater than 1mm (wire)<br>no protection against the ingress of moisture                               |
|  | protected against ingress of solid bodies greater than 1mm (wire)<br>protected against sprays of water up to 60 degrees from the vertical (rain) |
|  | protected against ingress of solid bodies greater than 1mm (wire)<br>protected against water splashed from all directions                        |
|  | protected against limited ingress of dust (wet rooms/covered outdoor areas)<br>protected against water splashed from all directions              |
|  | protected against ingress of dust<br>protected against jets of water   |
|  | protected against ingress of dust<br>protected against powerful jets of water or heavy seas  |
|  | protected against ingress of dust<br>protected against immersion of water between 15cm - 1m for 30 minutes                                       |
|  | protected against ingress of dust<br>protected against immersion of water under pressure for long periods  |

## IK RATING

|   |   |
|---|---|
|  | protected against 0.14 joules impact (equivalent to 0.25kg mass dropped from 56mm above the surface)  |
|  | protected against 0.2 joules impact (equivalent to 0.25kg mass dropped from 80mm above the surface)   |
|  | protected against 0.35 joules impact (equivalent to 0.25kg mass dropped from 140mm above the surface) |
|  | protected against 0.5 joules impact (equivalent to 0.25kg mass dropped from 200mm above the surface)  |
|  | protected against 0.7 joules impact (equivalent to 0.25kg mass dropped from 280mm above the surface)  |
|  | protected against 1 joules impact (equivalent to 0.25kg mass dropped from 400mm above the surface)    |
|  | protected against 2 joules impact (equivalent to 0.5kg mass dropped from 400mm above the surface)     |
|  | protected against 5 joules impact (equivalent to 1.7kg mass dropped from 300mm above the surface)     |
|  | protected against 10 joules impact (equivalent to 5.0kg mass dropped from 200mm above the surface)    |
|  | protected against 20 joules impact (equivalent to 5.0kg mass dropped from 400mm above the surface)    |